

Heritage

\$5,164
16' W x 8' D x 12' H

Standard with House

- "L" shaped staircase
- Decorative Fireplace
- Wrap around porch with swing
- Room with vaulted ceiling
- Two dormers
- Picture window
- 7 Shutter Windows
- Hexagon Window
- 2 Side Light Windows
- Cedar Trim

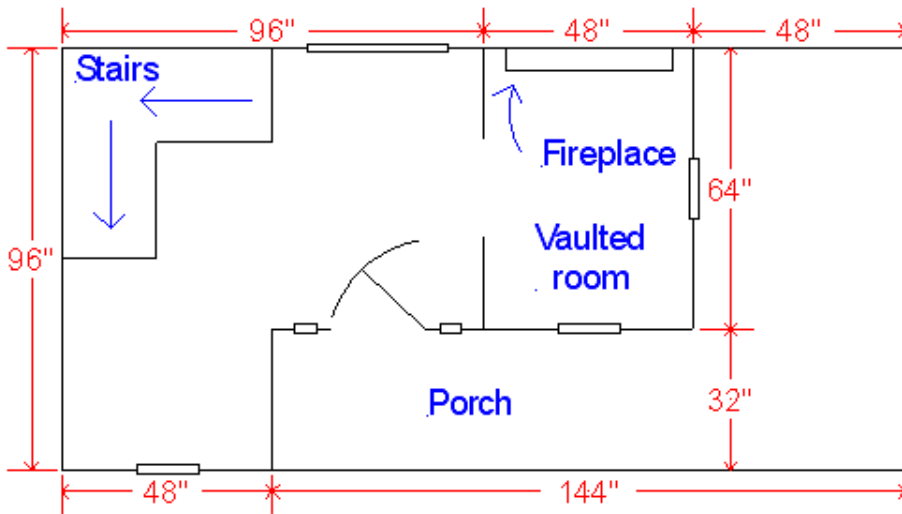

Heritage lower floor plan

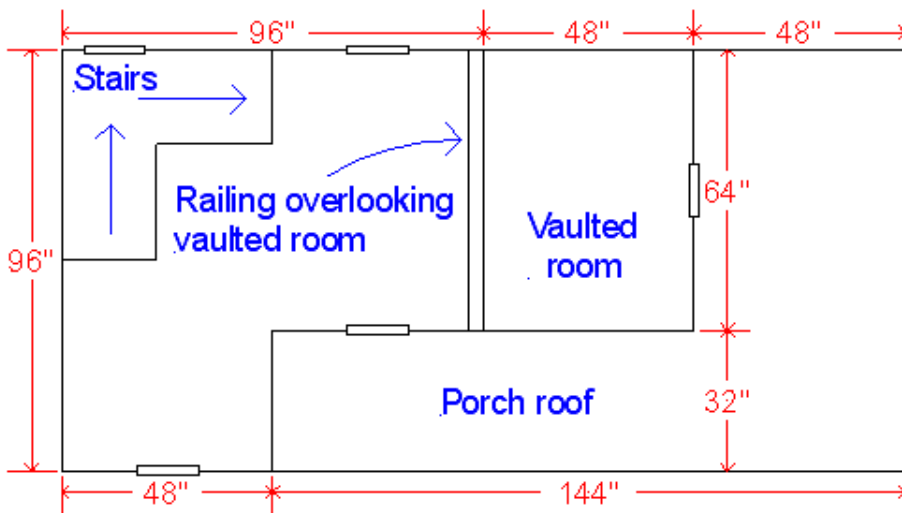

Heritage upper floor plan



Optional Accessories

- Vinyl windows (\$770)
- Bay window (\$175)
- 4 x 8 deck (\$299)
- Rock climbing wall (\$275)
- Slide (\$200)
- Fireman pole (\$150)
- 4 x 8 redwood deck (\$370)
- Redwood porches (\$275)

Mini Country Cottage

\$4,070

12' W x 8' D x 12' H

*(Shown with optional bay window and vinyl windows)

Standard with House

- L shaped staircase
- Decorative Fireplace
- Wrap around porch with swing
- 12" x 18" Grid window above door
- 5 Shutter Windows
- 2 Side Light Windows
- Cedar Trim

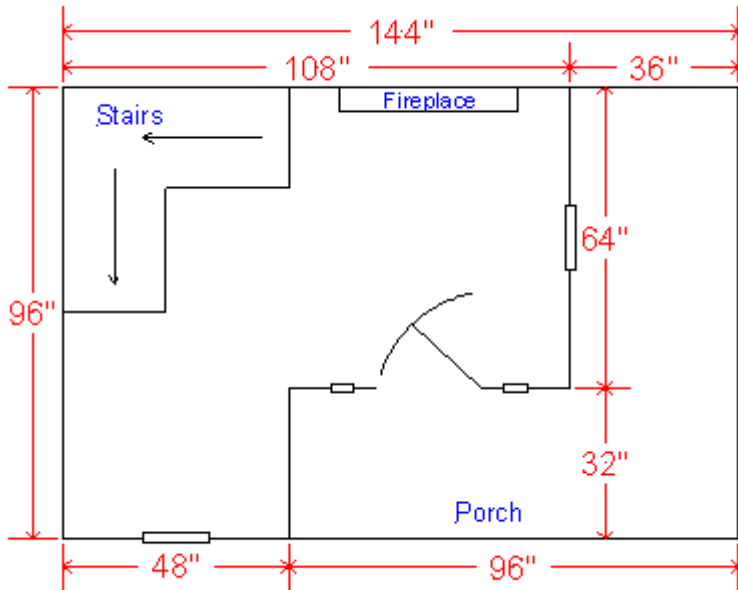

Mini Country Cottage lower floor plan

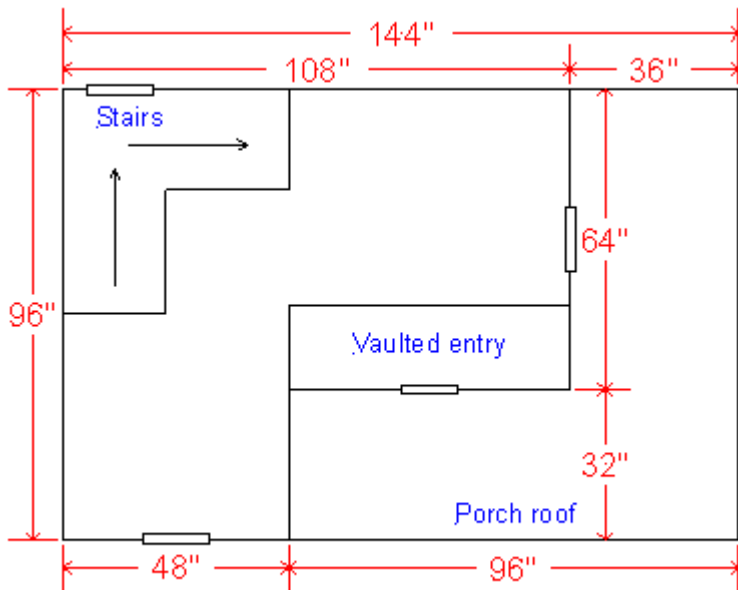

Mini Country Cottage upper floor plan



Optional Accessories

- Vinyl windows (\$550)
- Bay window (\$175)
- 4 x 8 deck (\$299)
- Rock climbing wall (\$275)
- Slide (\$200)
- Fireman pole (\$150)
- 4 x 8 redwood deck (\$370)
- Redwood porches (\$275)

Country Cottage

\$4,549
15 1/2' W x 8' D x 12' H

Standard with House

- "L" Shaped staircase
- Decorative Fireplace
- Wrap around porch with swing
- Room with vaulted ceiling
- 5 Shutter Windows
- 2 Hexagon Windows
- 2 Side light Windows
- Cedar Trim

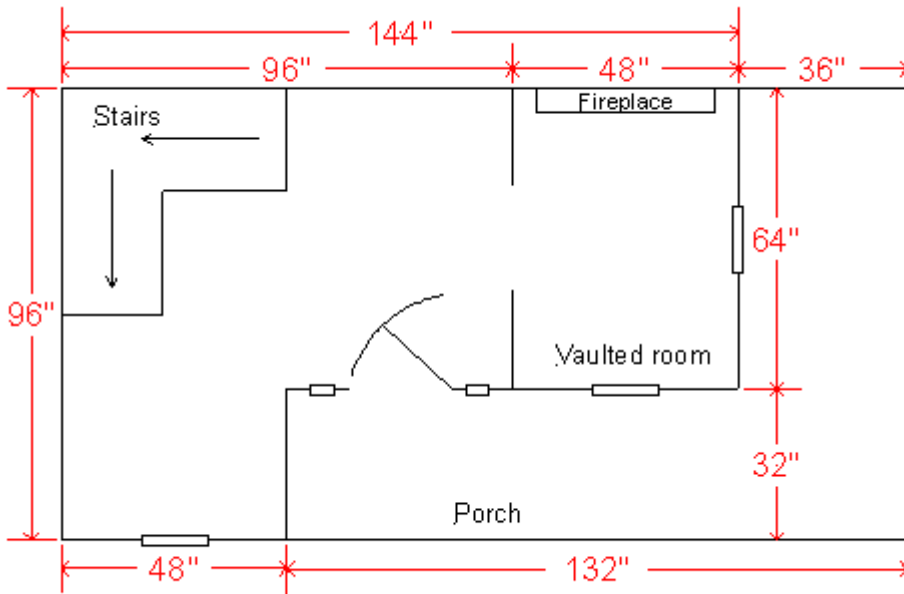

Country Cottage lower floor plan

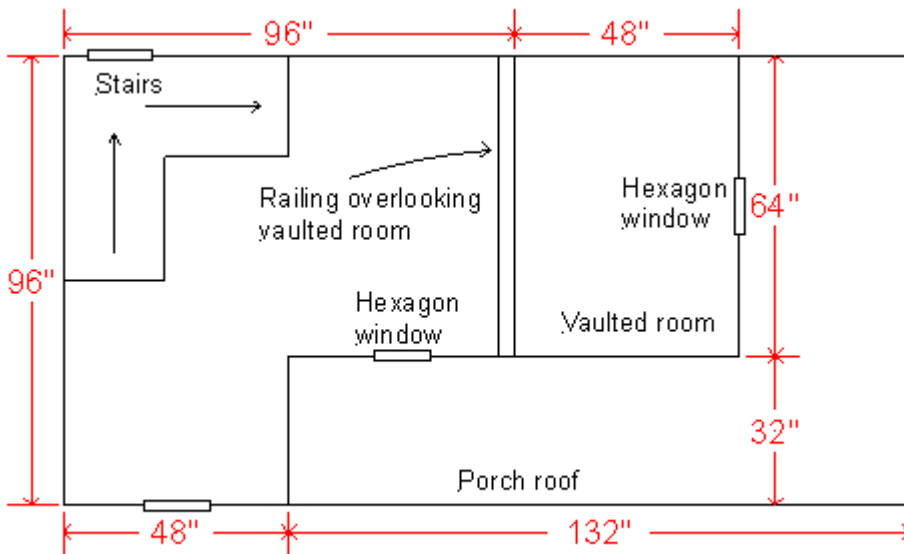

Country Cottage upper floor plan



Optional Accessories

- Vinyl windows (\$550)
- Bay window (\$175)
- 4 x 8 deck (\$299)
- Rock climbing wall (\$275)
- Slide (\$200)
- Fireman pole (\$150)
- 4 x 8 redwood deck (\$370)
- Redwood porches (\$275)

Cottage

\$4,289

12' W x 8' D x 11' H

(shown with optional bay window and vinyl windows)

Standard with House

- "L" shaped staircase
- Decorative Fireplace
- 32" Front porch with swing
- Room with vaulted ceiling
- 5 Shutter Windows
- Hexagon Window
- 2 Side Light Windows
- Cedar Trim

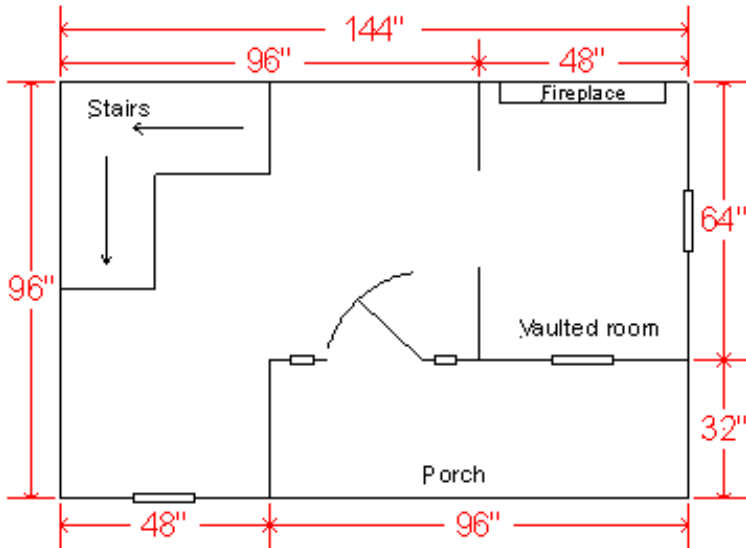
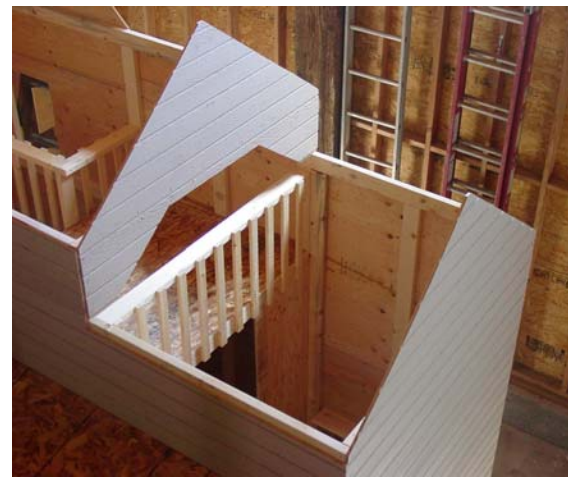

Cottage lower floor plan

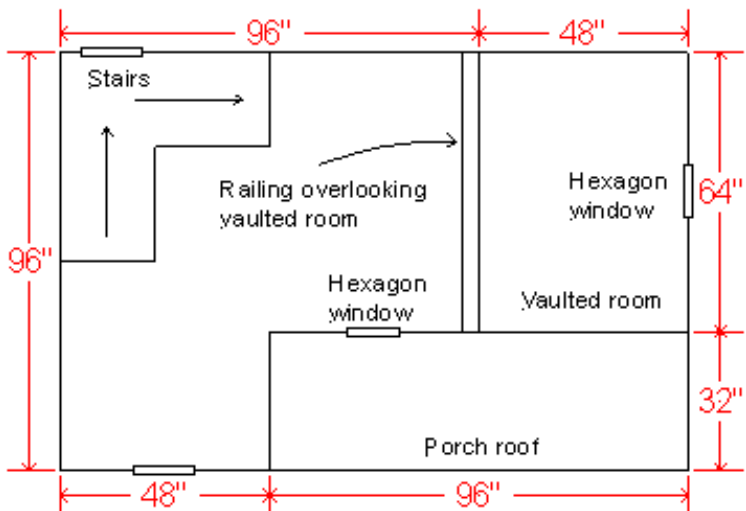

Cottage upper floor plan

Optional Accessories

- Vinyl windows (\$550)
- Bay window (\$175)
- 4 x 8 deck (\$299)
- Rock climbing wall (\$275)
- Slide (\$200)
- Fireman pole (\$150)
- 4 x 8 redwood deck (\$370)
- Redwood porches (\$275)

Swiss Miss

\$4,395
12' W x 8' D x 12' H

Standard with House

- Straight staircase
- Decorative Fireplace
- Bay window
- 3 12" x 18" Grid windows
- 4 Shutter Windows
- 2 Side Light Windows
- Cedar Trim

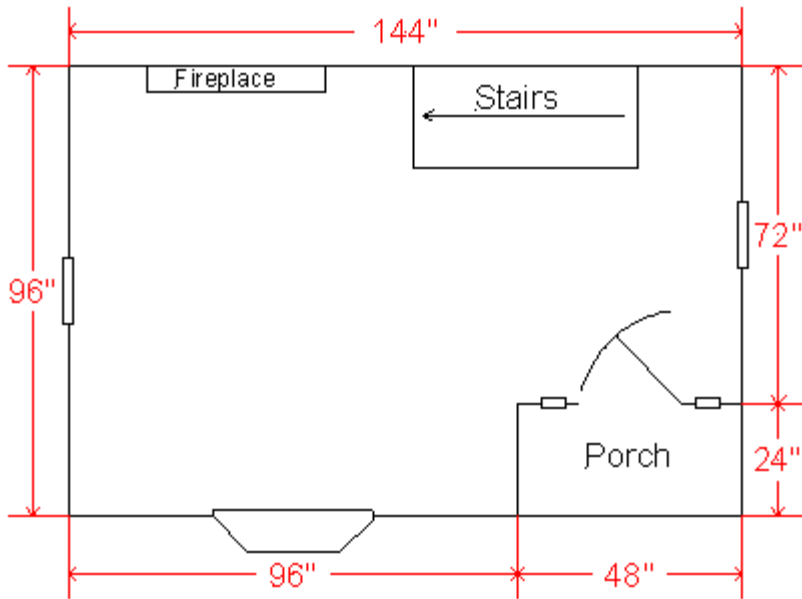

Swiss Miss main floor

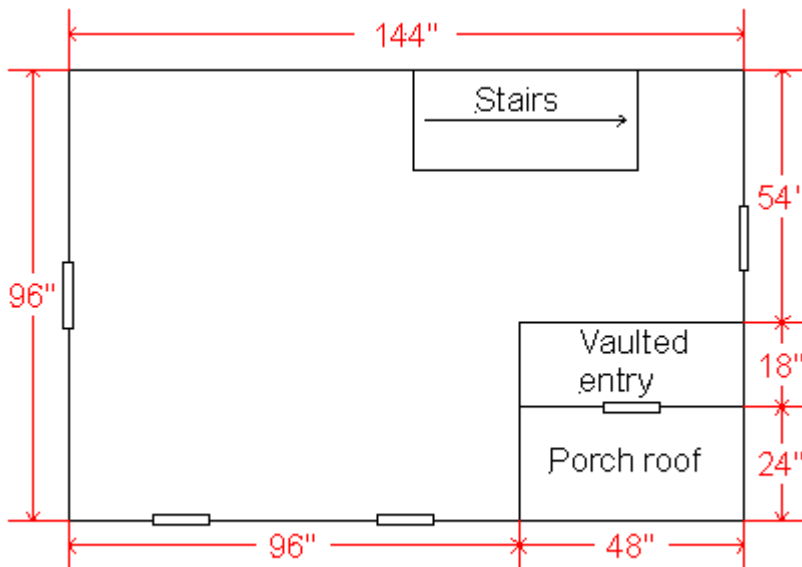

Swiss Miss upper floor

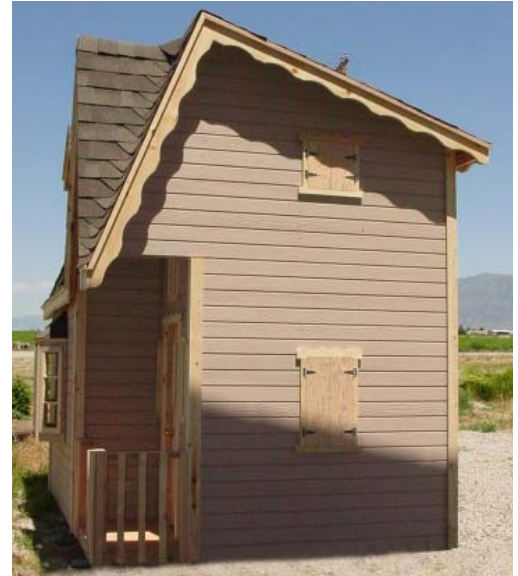

Optional Accessories

- Vinyl windows (\$660)
- 4 x 8 deck (\$299)
- Rock climbing wall (\$275)
- Slide (\$200)
- Fireman pole (\$150)
- 4 x 8 redwood deck (\$370)
- Redwood porches (\$275)

Queen Anne

\$7,295

23' W x 13' D x 14' H

Standard with House

- "L" Shaped staircase
- Decorative Fireplace
- Wrap around porch with swing
- Vaulted entry
- 4' x 8' Elevated Deck
- 11 Shuttered Windows
- Bay Window
- Hexagon Window
- 2 Side light Windows
- Cedar Trim



**Shown with optional Slide, Fireman Pole and vinyl windows

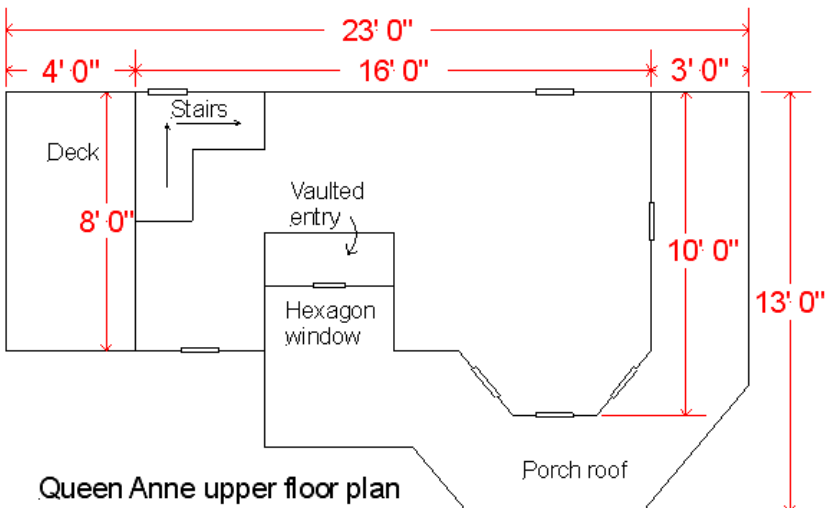
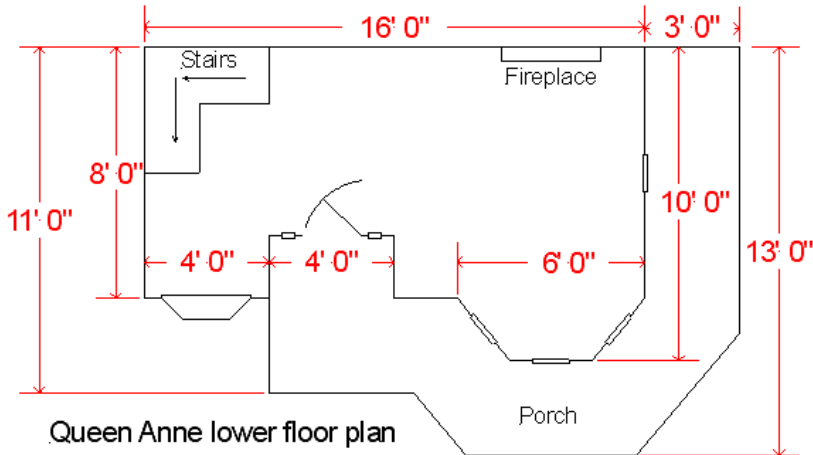

Optional Accessories

- Vinyl windows (\$1210)
- Rock climbing wall (\$275)
- Slide (\$200)
- Fireman pole (\$150)
- 4 x 8 redwood deck (\$370)
- Redwood porches (\$500)

Spoiler

\$4,379
12' W x 8' D x 12' H

Standard with House

"L" Shaped staircase
Decorative Fireplace
Wrap around porch with swing
Upper level deck with door
4 Shutter Windows
Hexagon Window
2 Side Light Windows
Cedar Trim

Optional Accessories

Vinyl windows (\$440)
Bay window (\$175)
Rock climbing wall (\$275)
Slide (\$200)
Fireman pole (\$150)
Redwood porches (\$375)

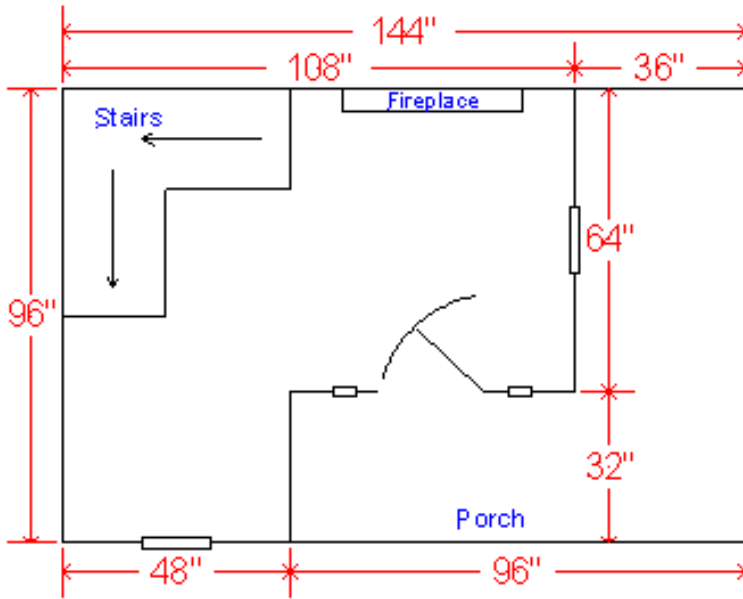

Spoiler lower floor plan

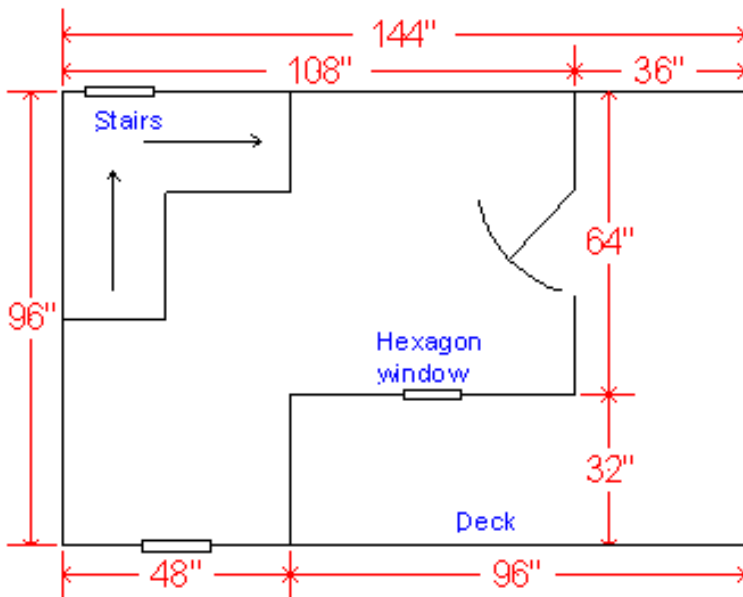

Spoiler upper floor plan



Club House

\$4,382

12' W x 12' D x 14' H

(shown with optional rock climbing wall and slide)



Standard with House

- Outside staircase
- Fireplace
- Rope swing
- Fireman pole
- 4 Shutter Windows
- Cedar Trim

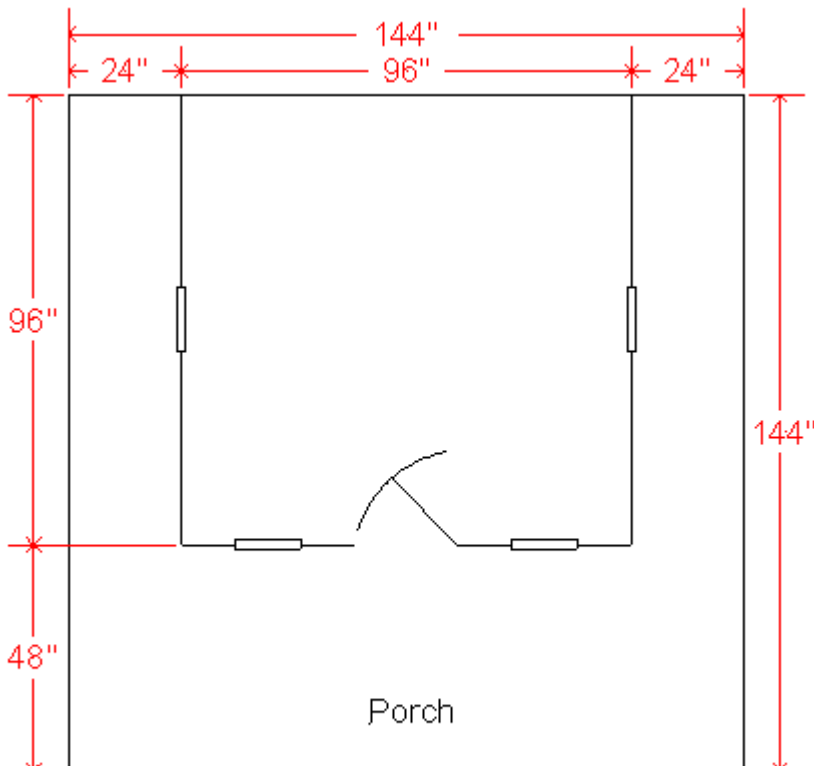

Club House floor plan



Optional Accessories

- Vinyl windows (\$440)
- Rock climbing wall (\$275)
- Slide (\$200)
- Redwood porches (\$375)

Country Gal

\$4,124

8' W x 12' D x 12' H

Standard with House

- Straight staircase
- Decorative Fireplace
- Upper balcony
- Front porch with swing
- 8 Shutter Windows
- Cedar Trim

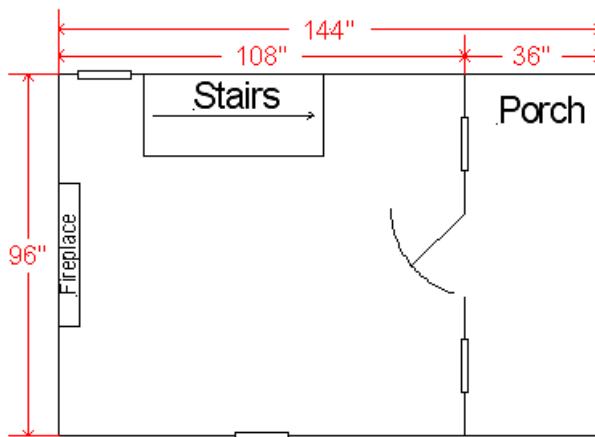

Country Gal main floor

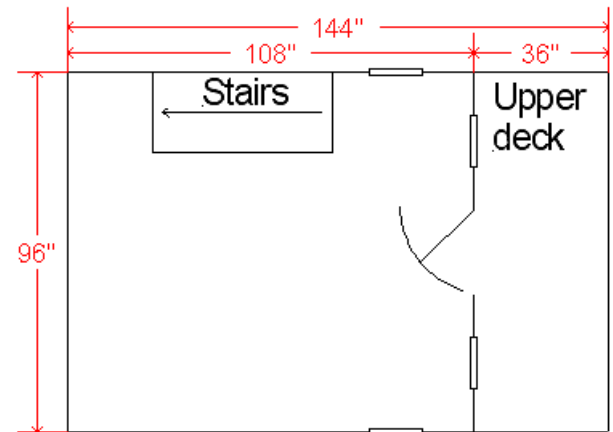

Country Gal upper floor

Optional Accessories

- Vinyl windows (\$880)
- Bay window (\$175)
- 4 x 8 deck (\$299)
- Rock climbing wall (\$275)
- Slide (\$200)
- Fireman pole (\$150)
- 4 x 8 redwood deck (\$370)
- Redwood porches (\$370)

Little Miss

\$2,495

8' W x 8' D x 8' H

*(Shown with optional vinyl windows)

Standard with House

Decorative Fireplace
3 Shutter Windows
2 Hexagon Windows
Cedar Trim

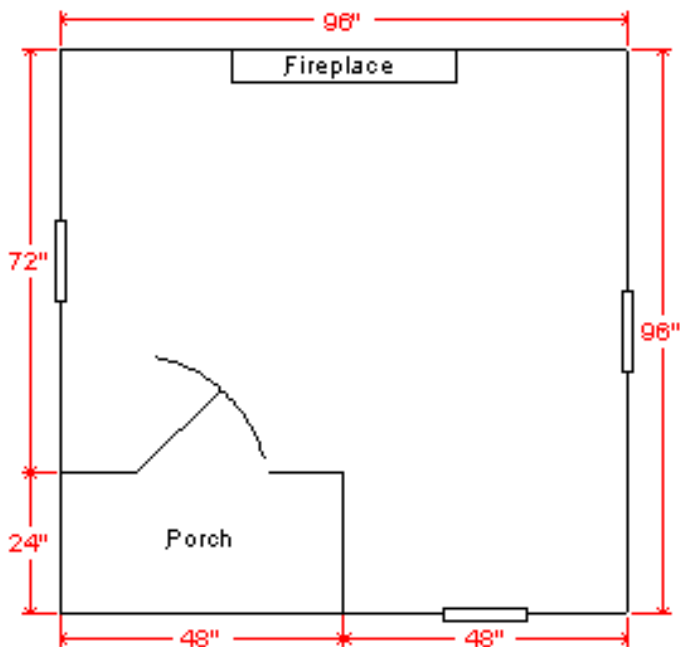

Little Miss floor plan

Optional Accessories

Vinyl windows (\$330)

Bay window (\$175)

Redwood porch (\$175)

Con do

\$3,814

8' W x 12' D x 12'

Standard with House

Straight staircase
Decorative Fireplace
32" Front porch with swing
9 Shutter Windows
Cedar Trim



Optional Accessories

- Vinyl windows (\$990)
- Bay window (\$175)
- 4 x 8 deck (\$299)
- Rock climbing wall (\$275)
- Slide (\$200)
- Fireman pole (\$150)
- 4 x 8 redwood deck (\$370)
- Redwood porches (\$275)

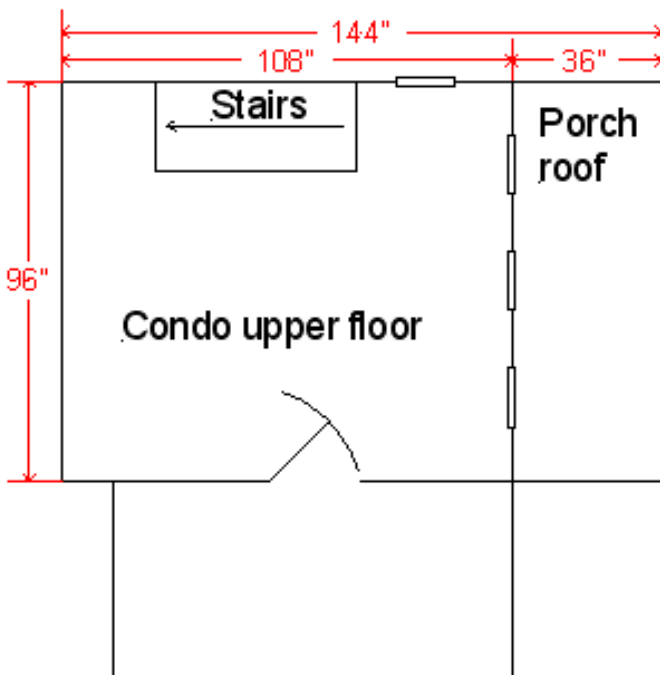
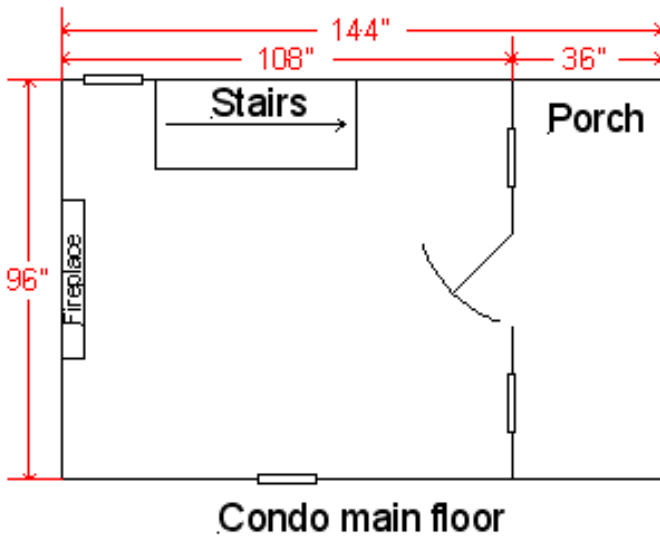

Victorian Castle

\$4,995
14' W x 8' D x 12' H

Standard with House

- "L" Shaped staircase
- Decorative Fireplace
- 16 Shuttered Windows
- Star Window
- 2 Side light Windows

**Shown with optional 4' x 8' Deck and vinyl windows

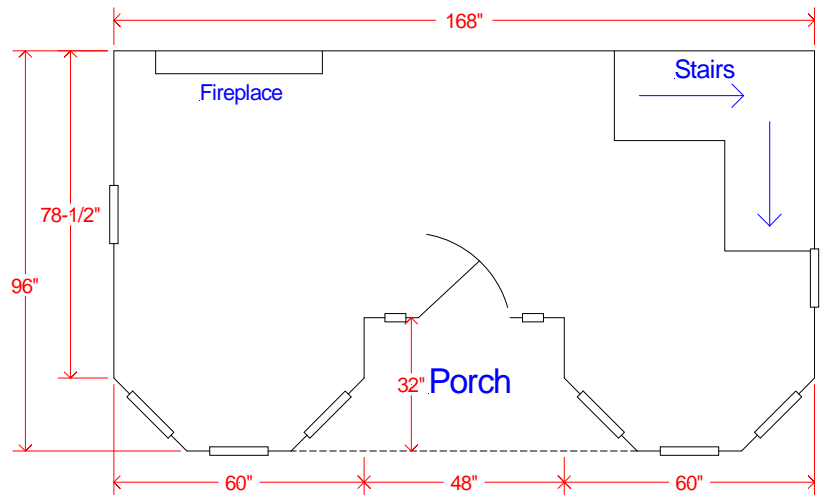

Castle Lower Floor

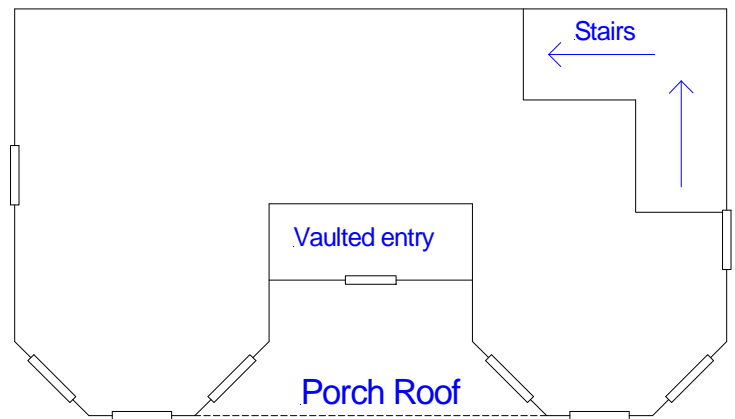

Castle Upper Floor

Optional Accessories

- Vinyl windows (\$1760)
- 4 x 8 deck (\$299)
- Rock climbing wall (\$275)
- Slide (\$200)
- Fireman pole (\$150)
- Redwood deck (\$370)
- Redwood porches (\$275)

The Cabin

\$5,284

14' W x 13' D x 12' H

Standard with House

- Loft with ladder
- 4 Vinyl windows
- Porch swing
- Adult size door

Optional Accessories

Redwood porches (\$325)

